

FIRÉZ™

EXCLUSIVE MEDIA WALL FIRES



^ Model shown: Firez 1250



HIGH

QUALITY, YOU CAN TRUST

We only use the highest quality materials and components in the manufacture of all our fires. This guarantees your fire will not only look amazing, but will be safe and reliable for years to come. All our fires come with a manufacturer's warranty.

TECH

STATE-OF-THE-ART TECH

All our fires use state-of-the-art tech, enabling you to easily control the temperature of the heater, and the colours of the ultra-realistic 3D flame and bed effects, all from the comfort of your armchair!



STYLE

DESIGNED IN THE UK

Firez fires have been designed in the UK by a team who have been working with fireplaces for over 30 years. Our mission to be at the forefront of interior trends has led to the development of our range of panoramic fires that are leading edge in media wall technology.

PANORAMIC FIRES:
RANGE & FEATURE OVERVIEW 4

1250 8

1500 10

1600 12

1800 14

2200 16

SLIMLINE 1500 18

SLIMLINE 1800 20

REAL HOMES
SEE ACTUAL INSTALLS 22

TECHNICAL
SPECS 24

FEATURES

ALL OUR FIRES FEATURE:

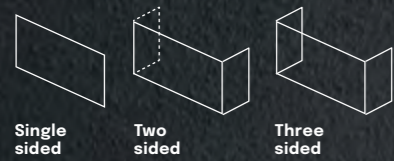

1, 2 OR 3-SIDED

There are three installation options with all our fires, with all the components included in the box.

- 1. Single sided installation** - for a hole in the wall type effect.
- 2. Two sided installation** - where the front and a side are required.
- 3. Three sided installation** - where three sides are visible.

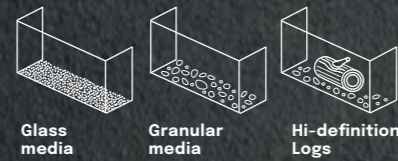

CHOICE OF SUPPLIED FUEL BED

All our fires come complete with a selection of fuel bed components so you can personalise your fire to your own personal taste. Choose from a high definition Woodland Ceramic Log effect fuel bed, clear or smoked tinted crystals and granular material, or get creative and use a combination! You can also choose to upgrade to our Deluxe Real Log Set for a step up in luxury and realism.



ULTIMATE FLAME PICTURE

Our 3D reflectory flame technology produces an ultra-realistic flame picture. Not only can you change the colour and intensity of the flame effect, you can also adjust the colour of the fuel bed and overbed lighting independently to create an ambience for any mood. All conveniently controlled from the included remote.



2.0Kw HEATER

Relax at your perfect temperature with the ultra-efficient built in 2.0Kw heater. The heater can be thermostatically or manually controlled. Simply set the temperature from your remote control for automatic function, or manually change the heater settings using either your remote or the push buttons discretely styled into the fascia of the fire.



EASY TO CONTROL

You can have full control of your fire colour and temperature, directly from your armchair using either the included remote control, connecting your fire to the app through your phone, or by connecting to Alexa. If your remote is not to hand, simply use the push-button controls which are discretely styled into the front of every fire.

Every fire in our range features state-of-the-art tech, so whichever size you choose you get the same advanced features...



FIRÉZ™ MEDIA WALL FLAME EFFECT FIRES

THE FUEL BED

All our fires come complete with a selection of fuel bed components so you can personalise your fire to your own personal taste.

Choose from a high definition Woodland Ceramic Log effect fuel bed, clear or smoked tinted crystals and granular material, or get creative and use a combination! You can also choose to upgrade to our Deluxe Real Log Set for a step up in luxury and realism.



^ Smoked & clear ember stones



^ Ultra realistic high definition Woodland Ceramic Log effect



^ Granular Stones



SEE THE DELUXE REAL LOG SET



^ Deluxe real logs in the manufacturing process

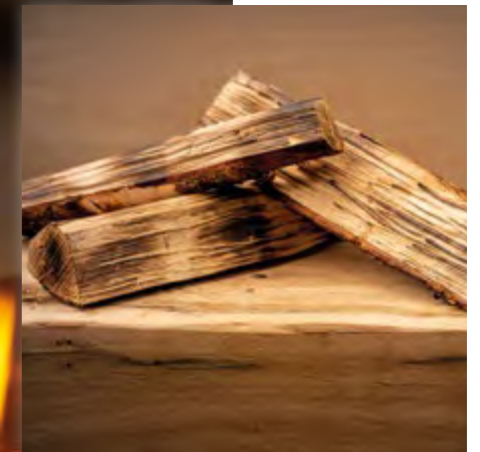

DELUXE REAL LOGS:

< Created using natural logs, our Deluxe Real Log set is the ultimate upgrade for both looks and realism. Fully customisable arrangement so that you can really tailor the look of your fire to your personal preferences.

FIREZ™

1250



Stylish yet compact, this fire is ideal for creating a focal point in smaller spaces.

All our Firez fire models feature 1, 2 or 3 sided panoramic glass variations giving you options of how to best incorporate this stunning fire into your room.

SEE THE FLAME EFFECT

PERFECT FOR TV SIZES UP TO
43"

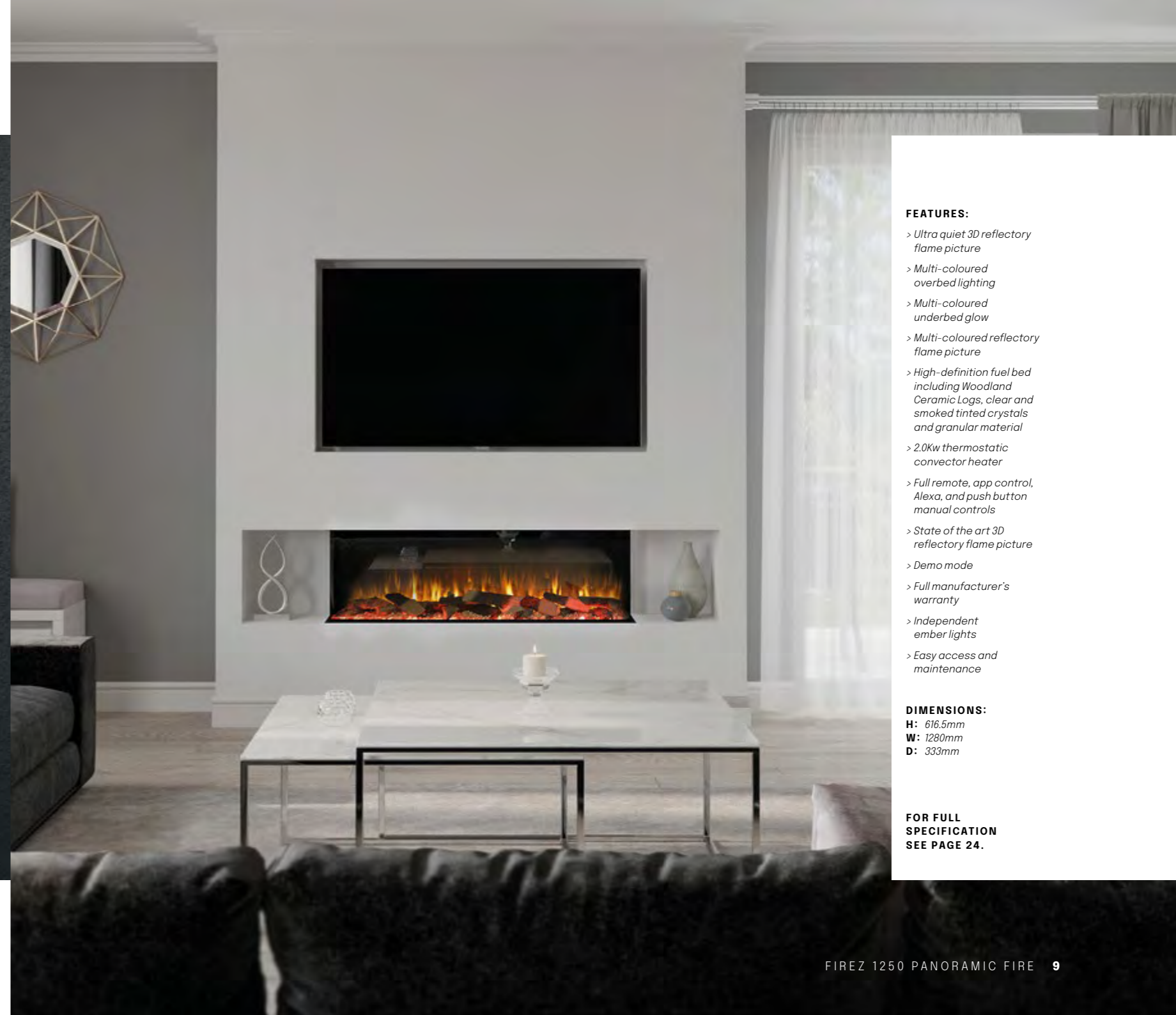

FEATURES:

- > Ultra quiet 3D reflectory flame picture
- > Multi-coloured overbed lighting
- > Multi-coloured underbed glow
- > Multi-coloured reflectory flame picture
- > High-definition fuel bed including Woodland Ceramic Logs, clear and smoked tinted crystals and granular material
- > 2.0Kw thermostatic convector heater
- > Full remote, app control, Alexa, and push button manual controls
- > State of the art 3D reflectory flame picture
- > Demo mode
- > Full manufacturer's warranty
- > Independent ember lights
- > Easy access and maintenance

DIMENSIONS:

H: 616.5mm
W: 1280mm
D: 333mm

FOR FULL SPECIFICATION SEE PAGE 24.

FIRÉZ™

1500

Our best-selling fire size with a beautiful wide-screen flame picture.

With a mixed interchangeable high-definition Woodland Ceramic Log effect fuel bed as standard on all models, and the option to upgrade to our Deluxe Real Log Set you have the freedom to set the fuel bed up to your own personal preference for a look that's unique to you.

SEE THE FIRE WORKING

PERFECT FOR TV SIZES UP TO
58"

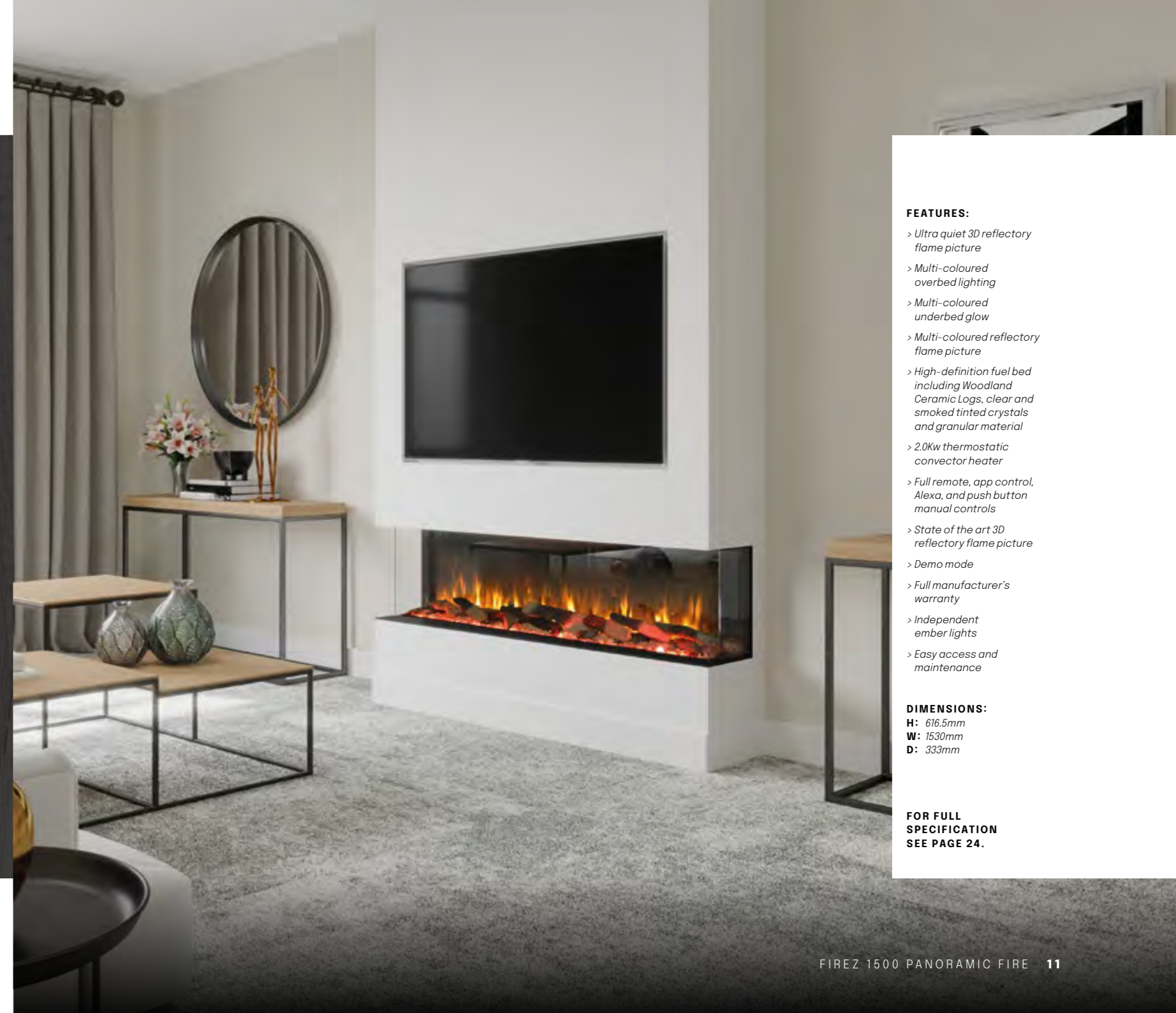

FEATURES:

- > Ultra quiet 3D reflectory flame picture
- > Multi-coloured overbed lighting
- > Multi-coloured underbed glow
- > Multi-coloured reflectory flame picture
- > High-definition fuel bed including Woodland Ceramic Logs, clear and smoked tinted crystals and granular material
- > 2.0Kw thermostatic convector heater
- > Full remote, app control, Alexa, and push button manual controls
- > State of the art 3D reflectory flame picture
- > Demo mode
- > Full manufacturer's warranty
- > Independent ember lights
- > Easy access and maintenance

DIMENSIONS:

H: 616.5mm
W: 1530mm
D: 333mm

FOR FULL SPECIFICATION SEE PAGE 24.

FIRÉZ™

1600

The increased width of the 1600 model offers greater flexibility for our customers with a larger TV.

Our fires have the aesthetics to rival that of a real wood burning fire, but without the hassle! Simply switch on with the included remote for instant ambience.

SEE THE FIRE WORKING

PERFECT FOR TV SIZES UP TO
60"



FEATURES:

- > Ultra quiet 3D reflectory flame picture
- > Multi-coloured overbed lighting
- > Multi-coloured underbed glow
- > Multi-coloured reflectory flame picture
- >> High-definition fuel bed including Woodland Ceramic Logs, clear and smoked tinted crystals and granular material
- > 2.0Kw thermostatic convector heater
- > Full remote, app control, Alexa, and push button manual controls
- > State of the art 3D reflectory flame picture
- > Demo mode
- > Full manufacturer's warranty
- > Independent ember lights
- > Easy access and maintenance

DIMENSIONS:

H: 616.5mm
W: 1630mm
D: 333mm

FOR FULL SPECIFICATION SEE PAGE 25.

FIREZ™

1800

The size of this fire makes it a show-stopping focal point in any room, and is perfect to build a full wall media installation around.

With Multi-option flame, overbed, and underbed lighting options available to select on all models with a click of your remote, you can easily create the look you want to suit your mood.

SEE THE FIRE WORKING

PERFECT FOR TV SIZES UP TO
70"



FEATURES:

- > Ultra quiet 3D reflectory flame picture
- > Multi-coloured overbed lighting
- > Multi-coloured underbed glow
- > Multi-coloured reflectory flame picture
- > High-definition fuel bed including Woodland Ceramic Logs, clear and smoked tinted crystals and granular material
- > 2.0Kw thermostatic convector heater
- > Full remote, app control, Alexa, and push button manual controls
- > State of the art 3D reflectory flame picture
- > Demo mode
- > Full manufacturer's warranty
- > Independent ember lights
- > Easy access and maintenance

DIMENSIONS:

H: 616.5mm
W: 1830mm
D: 333mm

FOR FULL SPECIFICATION SEE PAGE 25.

FIRÉZ™

2200



At 2200mm wide this panoramic gives you the ultimate wide-screen wow factor that fills even the largest of rooms with drama and the ultimate fireplace ambience.

Our largest wide-screen fire is packed with the same features as our other fires, but in this dramatic size suitable for larger installations including cinema rooms.



FEATURES:

- > Ultra quiet 3D reflectory flame picture
- > Multi-coloured overbed lighting
- > Multi-coloured underbed glow
- > Multi-coloured reflectory flame picture
- > High-definition fuel bed including Woodland Ceramic Logs, clear and smoked tinted crystals and granular material
- > 2.0Kw thermostatic convector heater
- > Full remote, app control, Alexa, and push button manual controls
- > State of the art 3D reflectory flame picture
- > Demo mode
- > Full manufacturer's warranty
- > Independent ember lights
- > Easy access and maintenance

DIMENSIONS:

H: 616.5mm
W: 2233mm
D: 333mm

FOR FULL SPECIFICATION SEE PAGE 26.

FIREZ™

SLIMLINE
1500



If you already have a chimney breast in your room taking up space there's no reason for you to miss out on one of our beautiful media walls.

Our range of slimline fires are only 190mm deep meaning a much shallower build off the front of your chimney, less than a traditional 380mm deep fireplace hearth! Boasting all the same visual features of our deeper range, and a 1.6kw heater, these fires are the perfect solutions to maximize your space and create an eye-catching centrepiece. The 1500 Slimline keeps the width of our best-selling fire, so you still get that fantastic flame picture!



PERFECT FOR TV
SIZES UP TO
58"



FEATURES:

- > Ultra quiet 3D reflectory flame picture
- > Multi-coloured overbed lighting
- > Multi-coloured underbed glow
- > Multi-coloured reflectory flame picture
- > High-definition fuel bed including Woodland Ceramic Logs, clear and smoked tinted crystals and granular material
- > 1.6Kw thermostatic convector heater
- > Full remote, app control, Alexa, and push button manual controls
- > State of the art 3D reflectory flame picture
- > Demo mode
- > Full manufacturer's warranty
- > Independent ember lights
- > Easy access and maintenance

DIMENSIONS:

- H:** 616.5mm
- W:** 1530mm
- D:** 207mm

FOR FULL SPECIFICATION SEE PAGE 27.

FIREZ™

SLIMLINE
1800



At 1800mm wide this slimline fire means you can create the same show-stopping look as with the deeper version, but without losing too much floor space.

The depth of the build will still allow you to recess your TV into an alcove for that clean flush look.



FEATURES:

- > Ultra quiet 3D reflectory flame picture
- > Multi-coloured overbed lighting
- > Multi-coloured underbed glow
- > Multi-coloured reflectory flame picture
- > High-definition fuel bed including Woodland Ceramic Logs, clear and smoked tinted crystals and granular material
- > 1.6Kw thermostatic convector heater
- > Full remote, app control, Alexa, and push button manual controls
- > State of the art 3D reflectory flame picture
- > Demo mode
- > Full manufacturer's warranty
- > Independent ember lights
- > Easy access and maintenance

DIMENSIONS:

H: 616.5mm
W: 1830mm
D: 207mm

FOR FULL SPECIFICATION SEE PAGE 27.



PERFECT FOR TV
SIZES UP TO
70"

FIRÉZ™

REAL HOMES

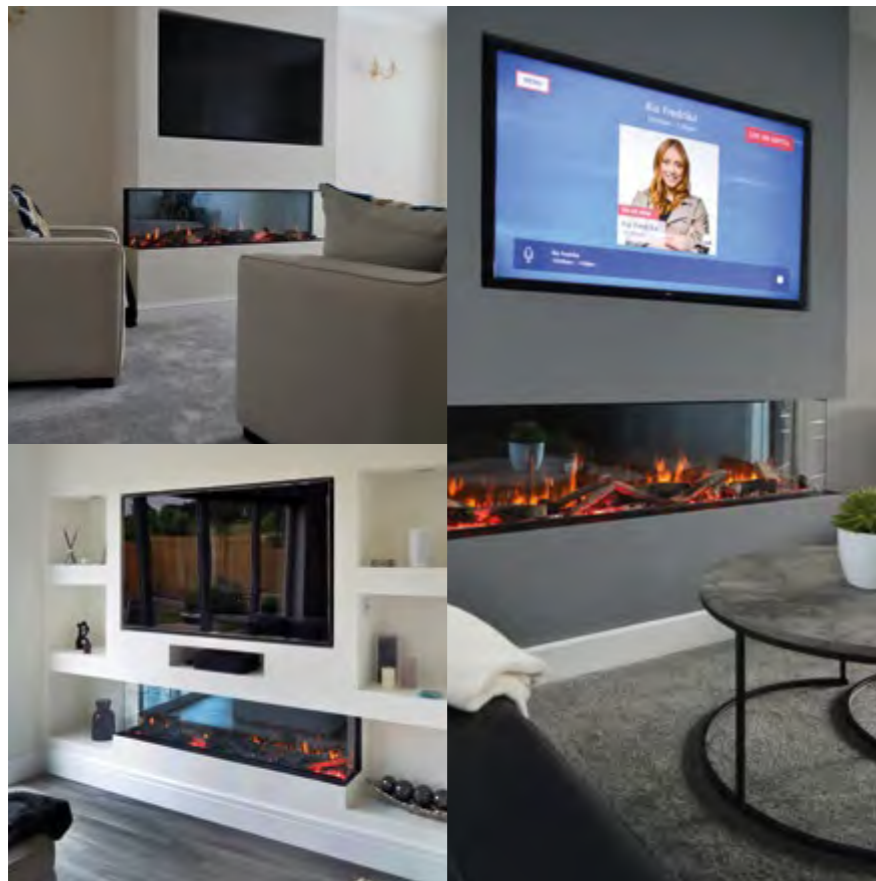

<< **FIRE:** FIREZ 1500

DESIGN: Constructed tight to the fire above and below, with bespoke built alcove for the TV.

Another media wall build that shows just how exquisite a simplistic design can turn out. Despite the relaxing, neutral tones throughout the room, it still has great character whilst also retaining that warm feeling. The different colour options and realistic shimmering effect on the under bed lighting in the Firez range pulls the whole theme together. Simple and classic.

< **FIRE:** FIREZ 1500

DESIGN: Constructed tight to the fire above and below, with bespoke built alcove for the TV.

This 3 sided effect media wall design is not only a beautiful sight from all angles, but it also shows how easy it really is to add a striking focal point to any room or space without having to give up much in return. The Firez 1500 takes the spotlight in this particular build giving a pop of colour to a stunningly decorated, elegant living space.

<< **FIRE:** FIREZ 1600

DESIGN: Wall-to-wall full alcove build with 3 alcove opening either side of the fire and TV.

Brilliantly minimalistic and complimentary of the whole living space, our full alcove builds can be built to whatever space you have there currently to achieve both a great new look to the room, but also additional storage options. If not, you can use the space to further elevate the room to a whole new level through intricate decoration and ornaments.



< **FIRE:** FIREZ 1800

DESIGN: Constructed tight to the fire above and below, with bespoke built alcove for the TV and 4 lit display alcoves to each side of the TV.

This extravagant media wall installation has seemingly both transformed the whole living space, whilst also managing to encapsulate the elegant look and feel in which the room had originally. The wall-to-wall masterpiece spans across over 4 metres, whilst also maintaining the simple, clean look finished off with some decorative details within each of the alcoves.

FIREZ™ MEDIA WALL FLAME EFFECT FIRES

SPEC

1250

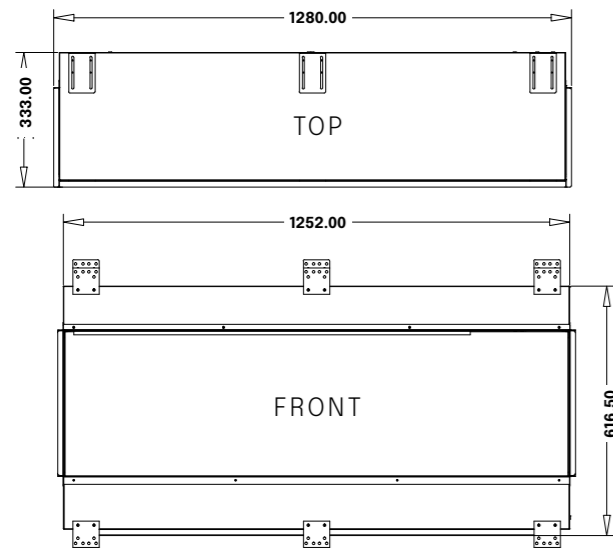
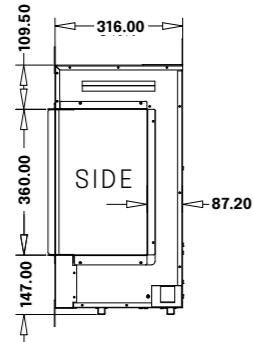
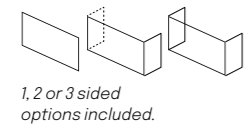

1500

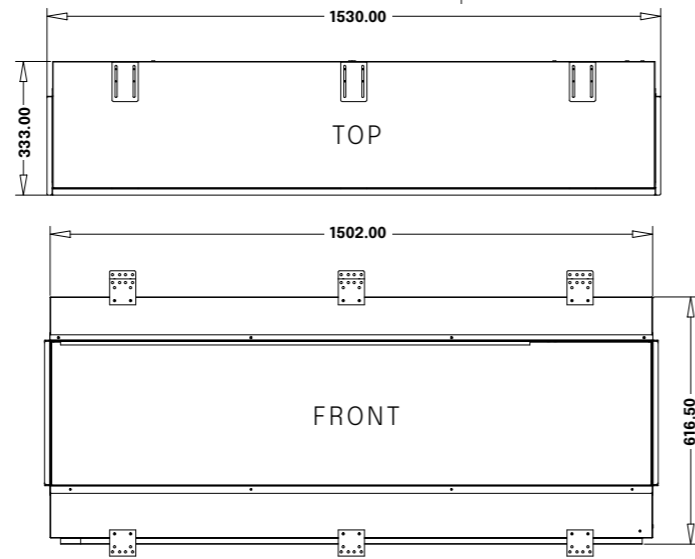
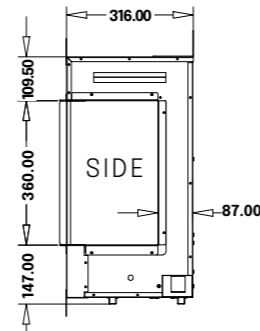

1600

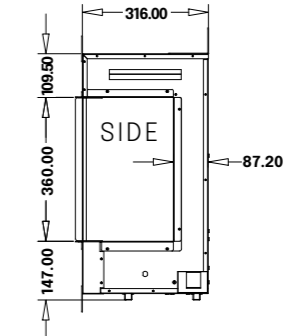
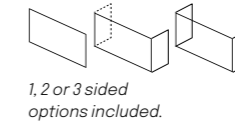
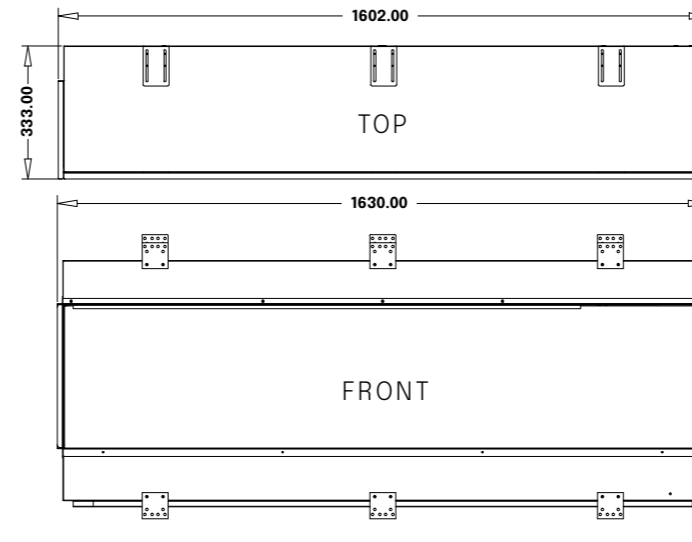

1800

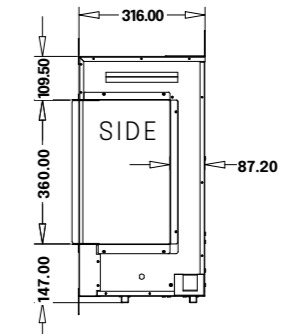
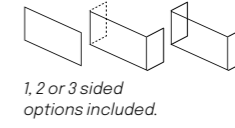
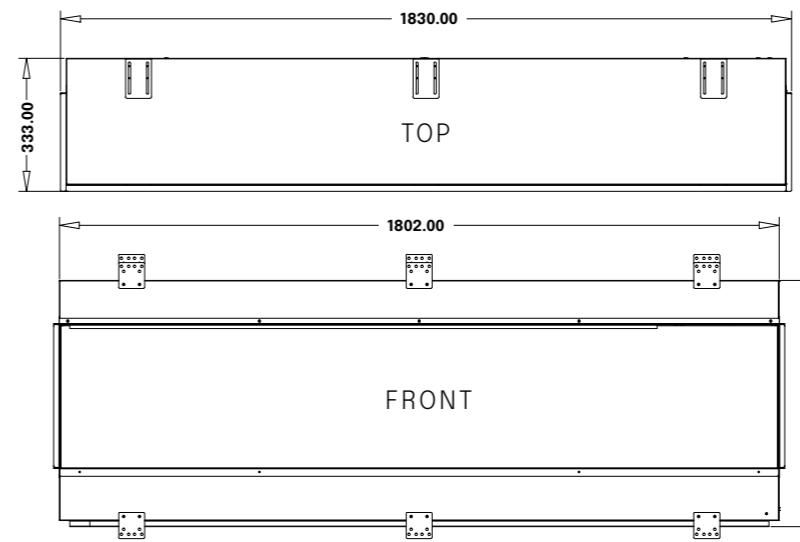

All fires have a 2.0Kw heater and include Firez 3D flame technology as standard.

FIREZ™ MEDIA WALL FLAME EFFECT FIRES

SPEC



All fires have a 2.0Kw heater and include Firez 3D flame technology as standard.

2200

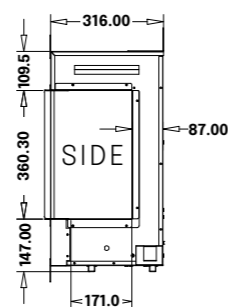
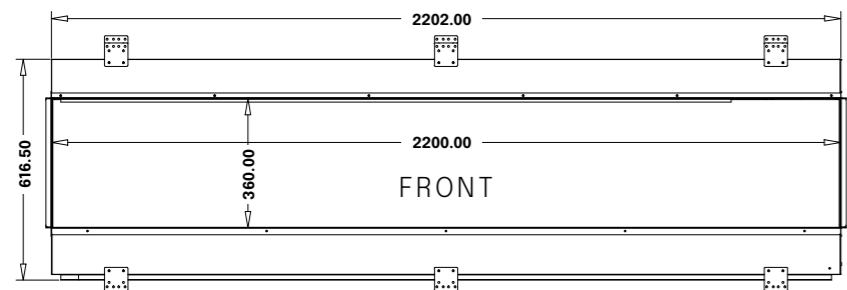
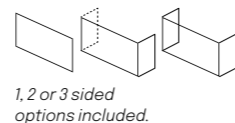
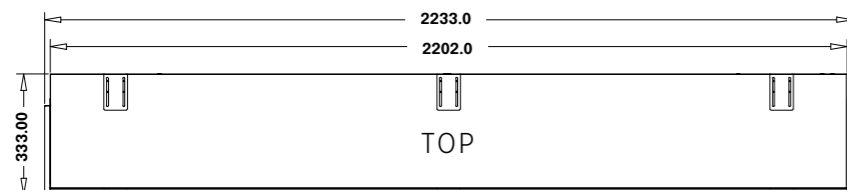

SLIMLINE 1500

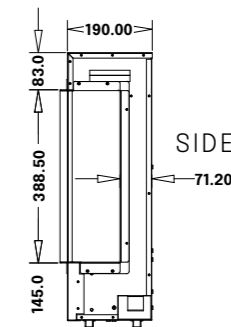
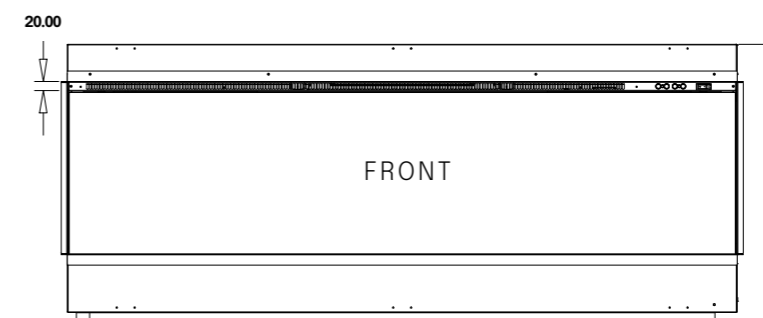
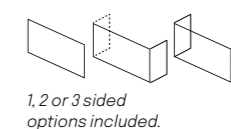
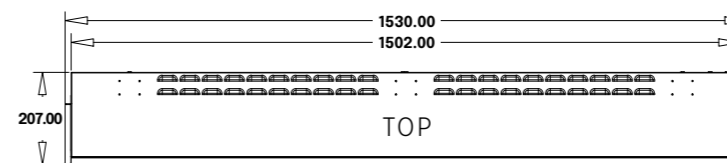

All fires have a 2.0Kw heater and include Firez 3D flame technology as standard.

SLIMLINE 1800

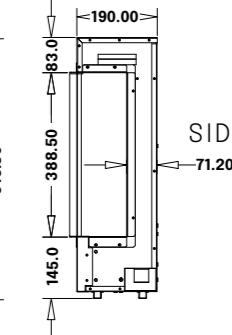
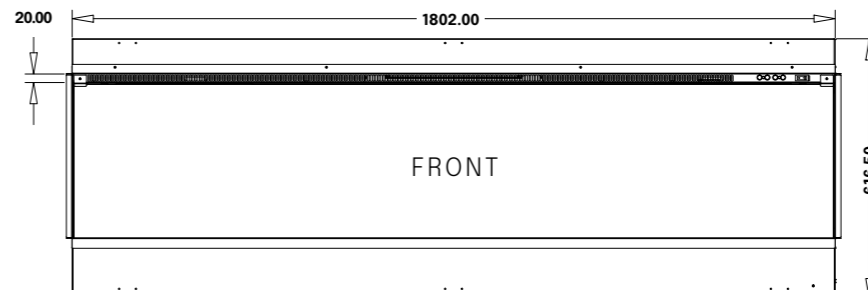
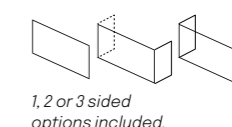
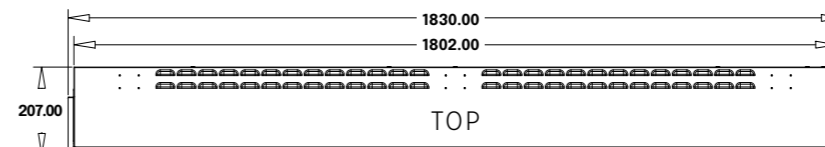

FIRÉZ™

EXCLUSIVE MEDIA WALL FIRES

YOUR AUTHORISED DEALER

FIREZ.CO.UK